



**Bulldoor**

# Our Values

- Innovation is part of us
- We embrace change as an opportunity to improve
- We take accountability on given commitments
- We give back to our community
- We are committed to honesty and transparency
- We work with integrity and high moral values in all business dealings

# History

Buldoor was started as a family company with one purpose in mind, and that was “To provide the best quality products with a great customer service in a more efficient and innovative manner, in order to help our clients gain and maintain their competitive advantage to succeed in their respective markets” This purpose has become our mission, and ever since we opened our doors in 2001 it has been our guiding star! Our commitment for quality, service, efficiency and innovation has guided us to become one of the most successful international supplies of goods around the world. With our corporate headquarters located in Southern California, our market reach stretches out from North to South America.

# Mission

“To provide the best quality products with a great customer service in a more efficient and innovative manner, in order to help our clients gain and maintain their competitive advantage to succeed in their respective markets”



Quality you  
can trust

# CONTENTS



家具脚轮产品  
Furniture feet wheel series

Page01-14



工业脚轮产品  
Industry feet wheel series

Page15-18



配件系列  
Accessories series

Page19-20



# Bulldoor

## 安装示意图

Installation indication

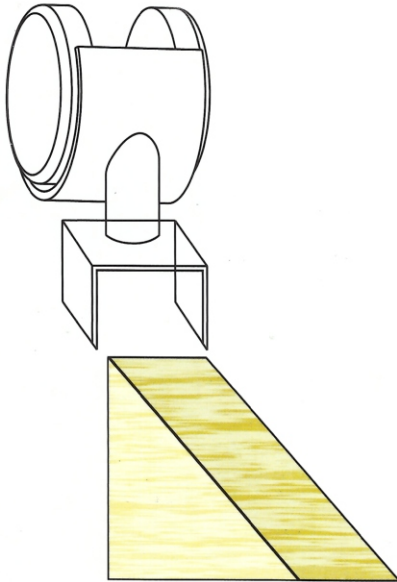

### 平底轮

钢片定位安装 (采用自动螺丝, 建议每个轮用四粒)  
Flatbottomed wheel  
Steel piece positioning installation (use auto screws, suggest using 4 screws for each wheel)

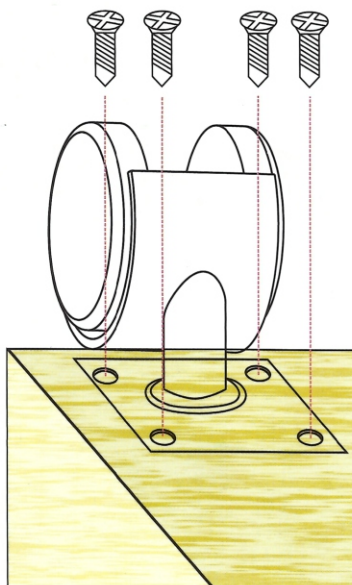

### 平板带制轮

将钢片位安装, (建议每只轮用四只自螺丝)  
Flat bottom furniture wheel  
Positioning installation of steel piece, (It's suggested to use four screws for each furniture wheel)

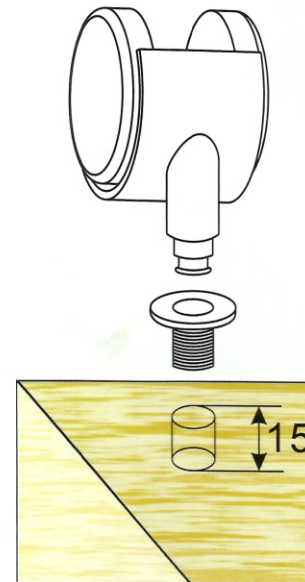

### 短插杆轮

先转孔, 然后击入预埋件, 再将轮压进预埋孔中。  
Short bar wheel  
First drill hole, then strike in embedded part, and then press the wheel in the hole.

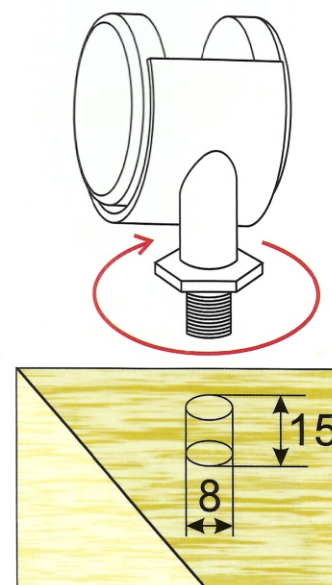

### 螺丝牙轮

先开孔, 然后击入相应预埋件, 再将螺丝旋转装入。  
Wheel with screws  
First drill hole, then strike in relevant embedded part, and then screw in for installation



# ***Bulldoor***



**飞度系列 FIT series**

2寸大班轮(无制)  
2-inch large sized wheel (without brake)

可选连接件 (铁) / Optional fittings (iron)

A. M10x15





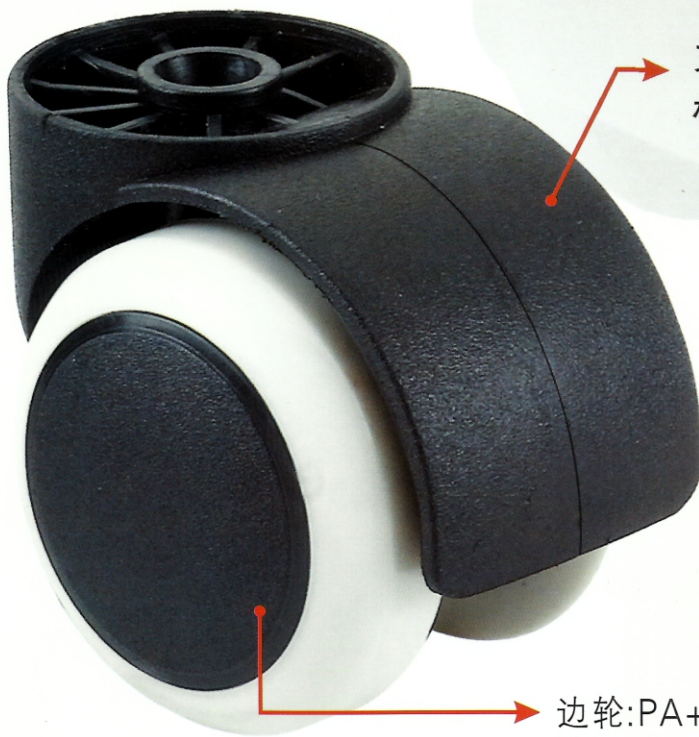



B. 10.8x20x20



支架 / Stand  
材料: PA / Material: PA

边轮: PA+PU 或 PP+PVC  
Side wheel: PA+PU or PP+PVC



							包装规格(CM) Packing specification (CM)
Φ49	55	47.5	58	57	82		30

**奥拓系列 Alto series**

 2寸、2.5寸中班轮  
 2-inch, 2.5-inch middle sized caster

连接配件 (铁) / Optional fittings (iron)







A. M8x15

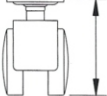

B. 10.8x20x20

 支架 / Stand  
 材料: PA / Material: PA

 边轮: / Side wheel:  
 材料: PA / Material: PA

								包装规格(CM) Packing specification (CM)
2寸	Φ50	43	47	62	44.5	77.5	30(KG)	58.5X28.6X27 200pcs/package
2.5寸	Φ60	50.5	55		64	84	30(KG)	

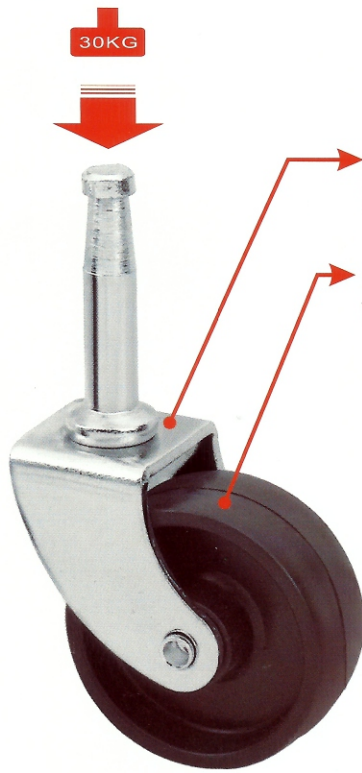
**小贵族系列 Small Elite series**
**1.5寸转向轮**  
 1.5-inch turning wheel

支架:铁2.0MM厚  
 Stand: Iron 2.00MM thickness

轮子:PP/颜色:黑色或白色  
 Wheel: PP/color: black or white

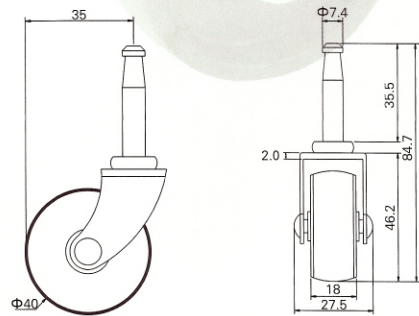

**1.5寸插杆轮**

## 1.5-inch Inserted link wheel

**小贵族系列 Elite series Small**

支架:铁2.0MM厚  
 Stand: Iron 2.00MM thickness

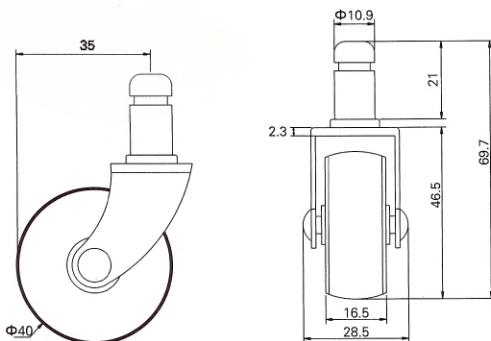
轮子:PP/颜色:黑色或白色  
 Wheel: PP/color: black or white





**QQ系列 QQ Series**

 1.2寸轮  
 1.2-inch wheel

1.5寸轮(无制)

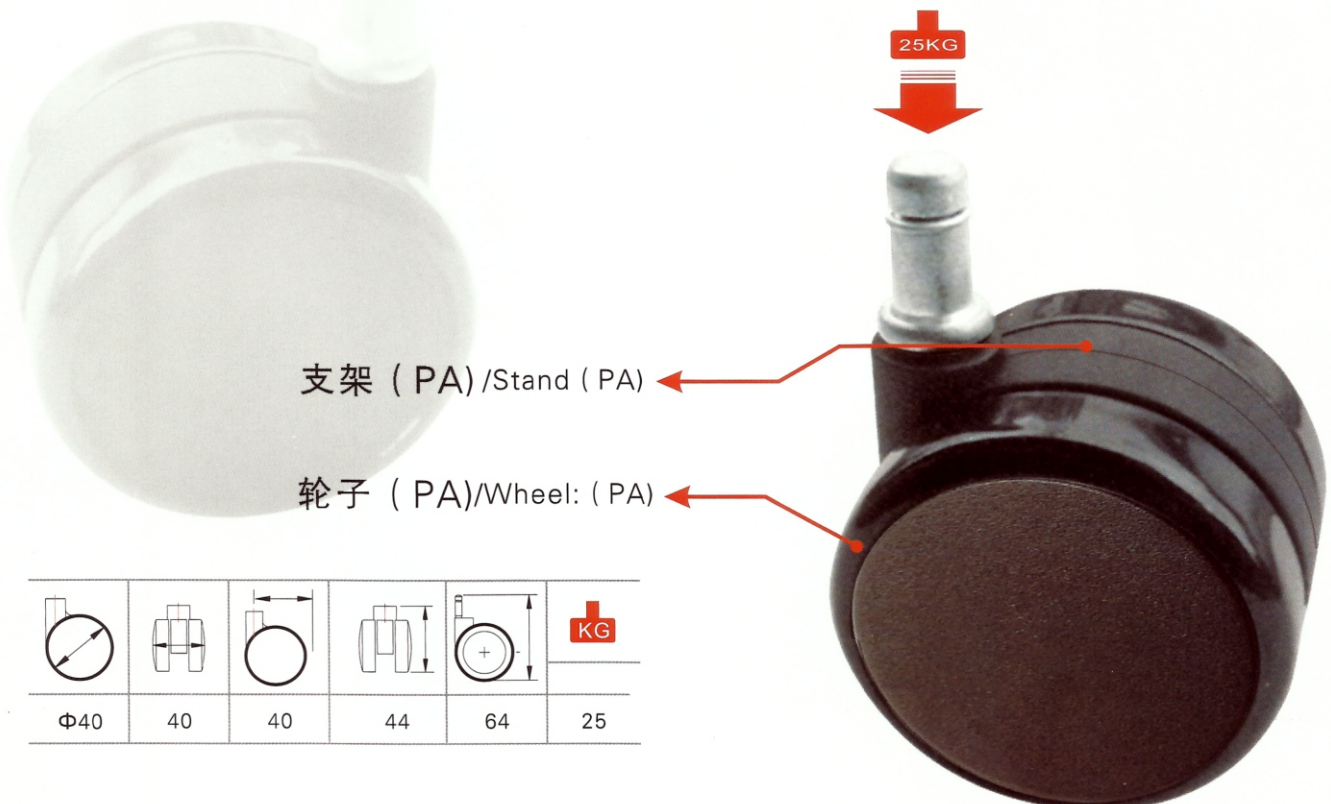
**QQ系列 QQ Series**



**奥迪系列 Audi series**

 1.5寸/2寸脚轮(有制/无制)  
 1.5-inch, 2-inch casters (with brake/without brake)



可选连接件 (铁) /Optional fittings (iron)

A.M10X15

B.M8X15

C.38X38X1.8

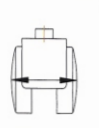
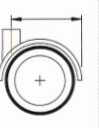
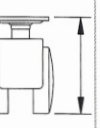
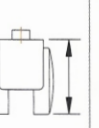
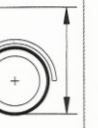

								包装规格(CM) Packing specification (CM)
1.5寸	Φ38(mm)	44(mm)	38(mm)	60(mm)	43.5(mm)	71(mm)	60(KG)	40X27X25.8
2寸	Φ50(mm)	54(mm)	43(mm)	68(mm)	71(mm)	85(mm)	80(KG)	35X28X25

雷克萨斯系列 Lexus series

2.5寸脚轮(有制/无制)  
2.5-inch caster (with brake/without brake)

可选连接件 (铁)/Optional fittings (iron)  
A.M8X15 / M10X15



B.47.5X47.5X1.8

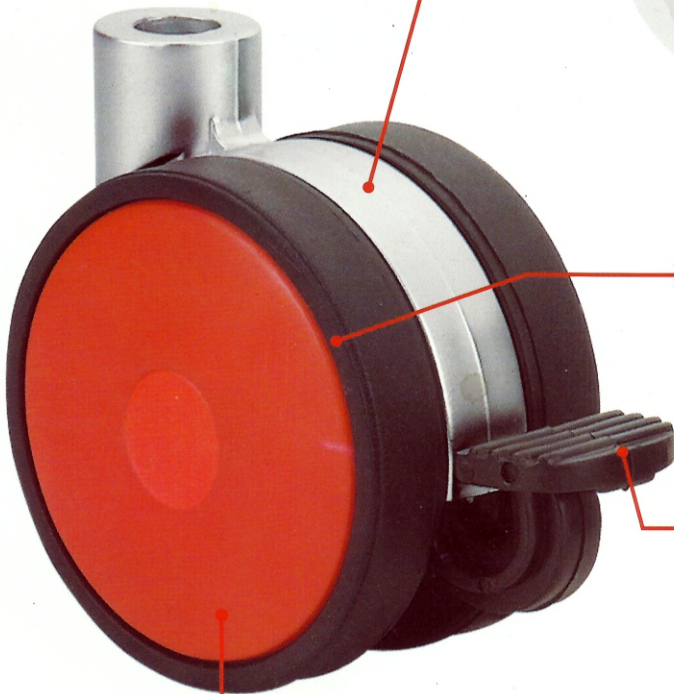





支架/Stand  
材料: 锌合金、合成  
Material: Zinc alloy、Compound

边轮:/Side wheel:  
材料:PA(PA+PU)  
Material :PA(PA+PU)

按键 /Button  
材料:PA/Material: PA

侧盖:可选颜色搭配  
Side cover: Optional colors:

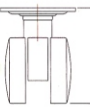
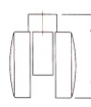

							包装规格(CM) Packing specification (CM)
Φ61(mm)	42(mm)	50(mm)	82(mm)	95(mm)	60(KG)		40x29x27

**红旗系列 Hongqi series**

 2寸、3寸脚轮(无制)  
 2-inch, 3-inch caster (without brake)

A.M8X15

B.47x47x18



灰色/Grey 蓝色/Blue 白色/White 红色/Red 黑色/Black



 侧盖:/Side cover:  
 可选颜色搭配/Optional colors:

 支架/Stand  
 材料:锌合金/Material: Zinc alloy

正面:/Front:

 轮:/Wheel  
 材料:ABC+PVC  
 Material:ABC+PVC

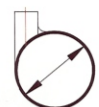
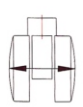
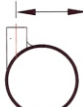
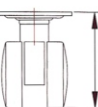
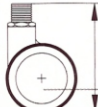
反面:/Back

						KG	包装规格(CM) Packing specification (CM)
2寸	Φ50(mm)	30(mm)	38(mm)	82(mm)		60(KG)	35x28.2x25.8
3寸	Φ78(mm)	68(mm)	68(mm)	100(mm)		85(KG)	

天籁系列 Teana series

3寸脚轮(有制/无制)

3-inch caster (with brake/without brake)

可选连接件 (铁)/Optional fittings (iron)

A.M8X15

B:47.5X47.5X1.8



支架/Stand  
材料: 锌合金、合成  
Material: Zinc alloy、Compound





按键/Button  
材料:PA/Material: PA

边轮:材料PA  
Side wheel material :PA

侧盖:可选颜色搭配  
Side cover:Optional colors  
材料:ABS /Material :ABS

灰色/Grey 蓝色/Blue 白色/White 红色/Red 黑色/Black

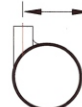
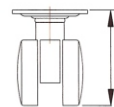
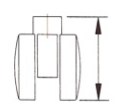

						 包装规格(CM) Packing specification (CM)
Φ82(mm)	46(mm)	72(mm)	100(mm)	130(mm)	60(KG)	

**凯迪拉克系列 Cadillac series**
**3寸脚轮**  
 3-inch caster







连接配件 (铁) / Optional fittings (iron)

A: 3\8GX 43.6

B: M12X20

C: 59X59X2.5



						 包装规格(CM) Packing specification (CM)
Φ75(mm)	63	75		84	80	

**神行者系列 Freeland series**
**3寸脚轮**  
 3-inch caster

可选连接件 (铁) / Optional fittings (iron)

A: 3\8GX 43.6



B: M12X20

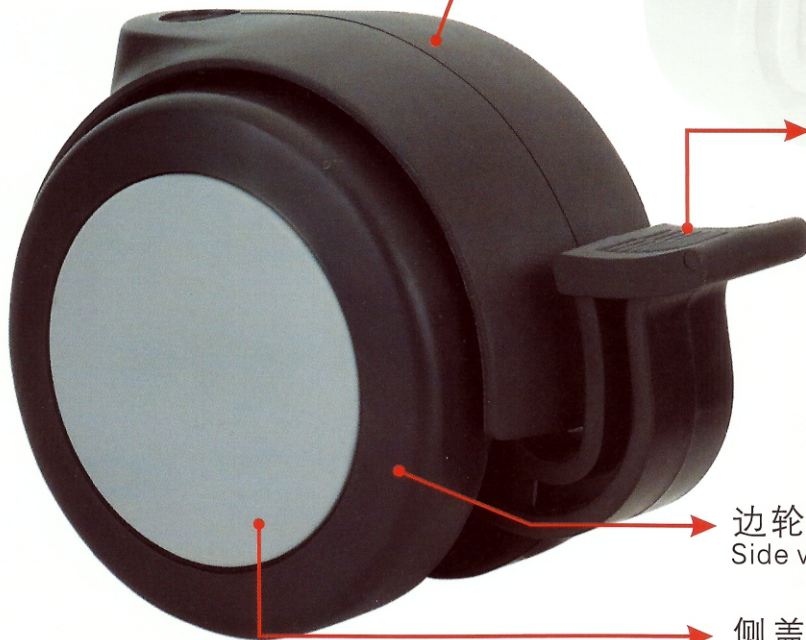

C: 59X59X2.5

 支架 / Stand  
 材料: PA/ABS  
 Material: PA/ABS





 按键 / Button  
 材料: PA / Material: PA

 边轮材料: PA+PU 或 PP+PVC  
 Side wheel material: PA+PU 或 PP+PVC

 侧盖: 可选颜色搭配  
 Side cover: Optional colors  
 材料: ABS / Material: ABS

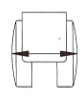
灰色 / Grey 蓝色 / Blue 白色 / White 红色 / Red 黑色 / Black

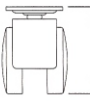
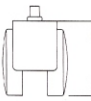

							包装规格 (CM) Packing specification (CM)
Φ78(mm)	68(mm)	78(mm)	100(mm)	85(mm)	130(mm)		150-200 (KG)



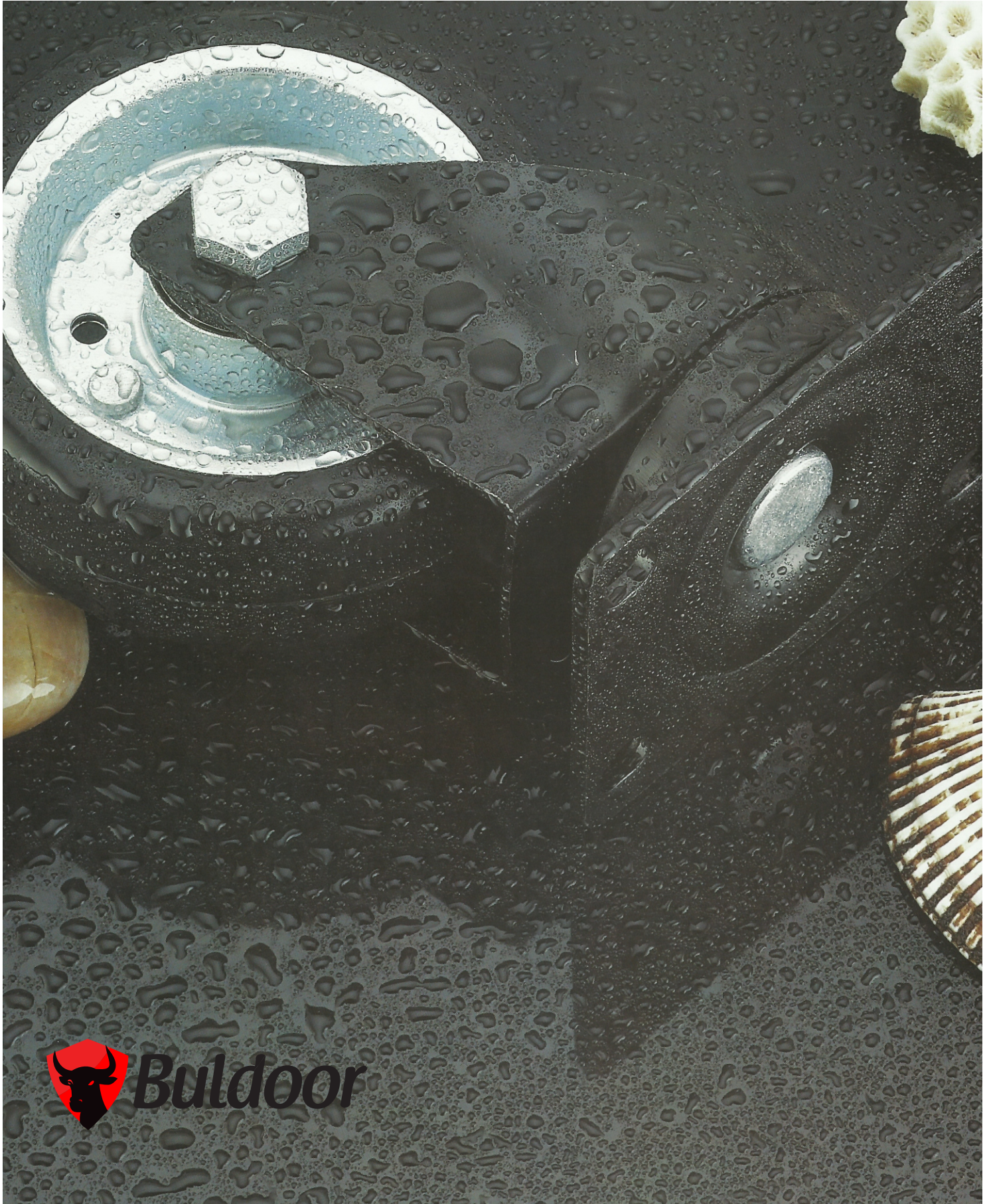

**捷豹系列 Jaguar series**
**3寸脚轮**  
 3-inch caster

可选连接件 ( 铁 ) / Optional fittings ( iron )

A: 3\8GX 43.6

B: M12X20

C: 59X59X2.5

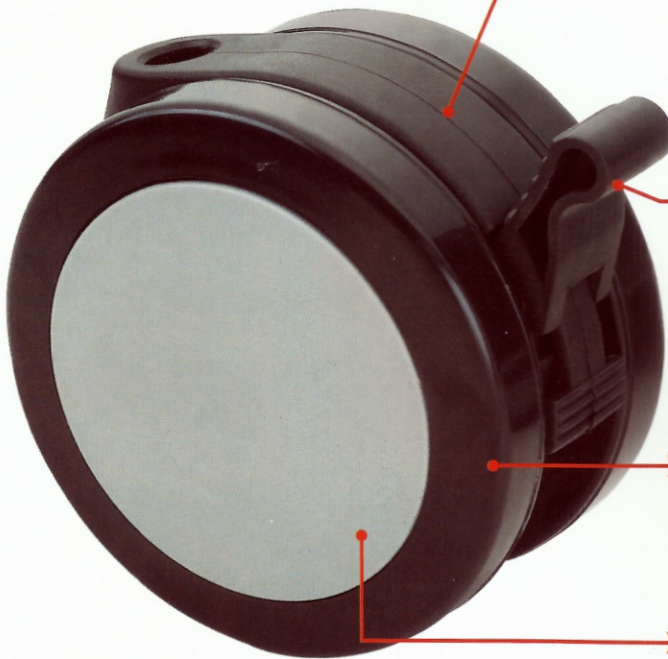
 支架 / Stand  
 材料: PP / Material: PP







 按键 / Button  
 材料: PP / Material: PP

 边轮材料: PA+PU 或 PP+PVC  
 Side wheel material: PA+PU 或 PP+PVC

 侧盖: 可选颜色搭配  
 Side cover: Optional colors  
 材料: ABS / Material: ABS

灰色 / Grey    蓝色 / Blue    白色 / White    红色 / Red    黑色 / Black









							包装规格 (CM) Packing specification (CM)
Φ80(mm)	50(mm)	60(mm)	100(mm)	80(mm)	123(mm)		80(KG)

**力帆系列 Lifan series**

**1.2寸定向轮**  
 1.2 Inch fixed caster

**1.5寸定向轮**  
 1.5 Inch fixed caster

单位: mm









名称 Item	 轮径	 轮宽	 底板尺寸	 孔距	 孔径	 安装高度	 承载	材料 Material
1.2寸定向轮 5 Inch fixed caster	31.5	13.3	37x18	29	4	40	20	PP+PU
1.5寸定向轮 5 Inch cardan with Brake	40	23	38x28	23x13	4		25	PP+PU

**陆风系列 Land wind series**

**2寸工业万向轮 (平板)**  
 2Inch cardan caster(flat plate)

**2寸工业万向轮 (螺杆)**  
 2Inch cardan caster(screw)

**2寸工业万向轮 (螺杆带刹)**  
 2Inch cardan caster (screw with brake)

名称 Item	 轮径	 轮宽	 轴承	 底板尺寸	 孔距	 孔径	 螺杆规格	 安装高度	 承载	材料 Material
2寸定向轮平板 2 Inch fixed caster	50	23	轴套	68x48	48x18	6		64	25	PP+PU
2寸万向螺杆 2 Inch cardan with Brake	50	23	轴套				10x15	64	25	PP+PU
2寸万向螺杆带刹 2 Inch cardan with Brake	50	23	轴套				10x15	64	25	PP+PU







陆风系列 Land wind series



2寸工业万向轮 ( 螺杆 )  
2 Inch cardan caster (screw)

2寸工业万向轮 ( 圆盖螺杆 )  
2 Inch cardan caster (round cap screw)

单位: mm

名称 Item	 轮径	 轮宽	 轴承	 安装高度	 螺杆规格	 承载	材料 Material
2寸万向轮 ( 螺杆 ) 2 Inch fixed caster	50	18	轴套	64	10x15	25	PP+PU
2寸万向 ( 圆盖螺杆 ) 2 Inch cardan with Brake	50	18	轴套	64	10x15	25	PP+PU









君悦系列 Buick series



3寸工业万向轮 ( 螺杆带刹 )  
3 Inch cardan caster (screw with brake)

3寸工业万向轮 ( 平板 )  
3 Inch cardan caster (flat plate)

3寸工业定向轮  
3 Inch fixed caster 单位: mm

名称 Item	 轮径	 轮宽	 轴承	 底板尺寸	 孔距	 孔径	 螺杆规格	 安装高度	 承载	材料 Material
3寸万向轮螺杆带刹 3 Inch fixed caster	75	54	滚珠/滚针				M10X18	106	300	PU
3寸万向轮平板 3 Inch cardan caster	75	54	滚珠/滚针	105x80	86x60	8		105	300	PU
3寸定向轮 3 Inch cardan caster	75	54	滚珠/滚针	105x80	86x60	8		105	300	PU

**悍马系列 Hummer series**

**4寸万向轮 (平板带刹)**









4 Inch cardan caster (flat plate with brake)

**4寸万向轮**

4 Inch cardan caster

**4寸万向轮 (螺杆带刹)**

4 Inch cardan caster (screw with brake)

名称 Item	 轮径	 轮宽	 轴承	 底板尺寸	 孔距	 孔径	 螺杆规格	 安装高度	 承载	材料 Material
4寸万向轮平板带刹 4 Inch fixed caster	100	32	滚针	96x67.5	74x44	8		133	80	PP+PU
4寸万向轮 4 Inch cardan with Brake	100	32	滚针	96x67.5	74x44	8		133	80	PP+PU
4寸万向轮螺杆带刹 4 Inch cardan with Brake	100	32	滚针				12x25	133	80	PP+PU

**威迪龙系列 Bugatti Veyron series**









**5寸平板带刹轮**

5 Inch flat with brake

**5寸定向轮**

5 Inch fixed caster

单位: mm

名称 Item	 轮径	 轮宽	 轴承	 底板尺寸	 孔距	 孔径	 安装高度	 承载	材料 Material
5寸平板带刹轮 5 Inch flat with brake	126	56	35	115x100	85x70	11	160	300	PP+PU
5寸定向轮 5 Inch fixed caster	126	56	35	115x100	85x70	11	160	300	PP+PU

**配件**  
Accessories series

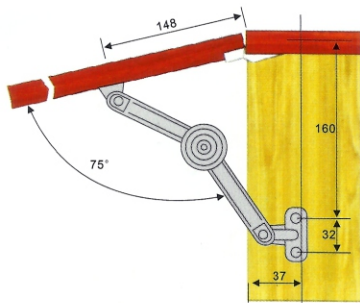
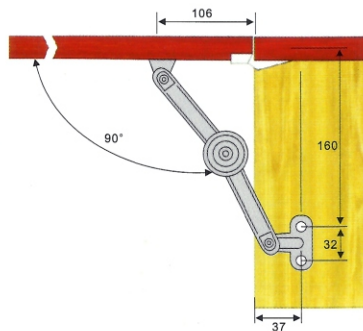
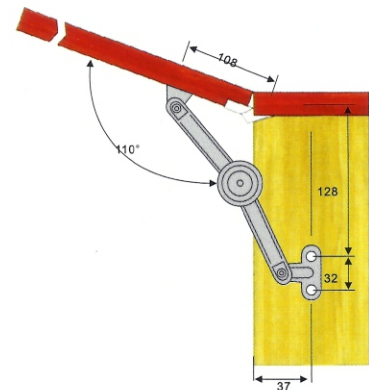
**安装孔位示意图**  
Installation indication

**75° 安装尺寸图**  
Installation sizes

**90° 安装尺寸图**  
Installation sizes

**110° 安装尺寸图**  
Installation sizes

**使用特点:**

用于厨柜的上翻木门和铝柜门。  
 开启角度: 通过改变安装尺寸, 上翻门最大开启角度可调整在75°, 90°和105°位置。上翻门在开启到最大开启度可停住, 其它任意位置为随意停状态及门板在任意位置可以停住。调整重新六角螺丝可承受不同重量的门板, 达到最佳效果。

Application features:  
 used in up-turn kitchen cabinet wooden door and aluminum cabinet door.  
 Opening angle: by changing installation dimensions, up-turn door max. Opening angle can be adjusted at 70°, 90° and 105° positions. Up-turn door can stop when opened to max. Opening angle. Other positions are random stop state and door panel can stop at any position. Through adjustment of center hex screw, it can bear different door panels of different weight, achieving best performance.

**标准技术表 Standard Technical Information**

表面处理: 镀铬  
 Finish: Chromium-plating  
 主要材质: 锌合金  
 Materials: Zinc alloy  
 适用范围: 各种柜门  
 Available for: All kinds of cabinet doors  
 特性: 支撑柜门板  
 Features: Supporting cabinet doors

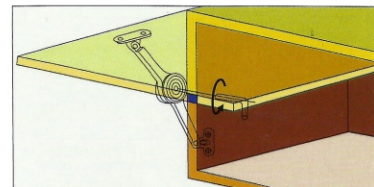



## Buldoor Hardware

647 Camino De Los Mares # 108-86,  
San Clemente, CA. 92673

United States

Phone: 877-388-1366

Fax: 877-366-7596

E-mail: [info@buldoor.net](mailto:info@buldoor.net)

[www.buldoor.net](http://www.buldoor.net)